

Data Sheet

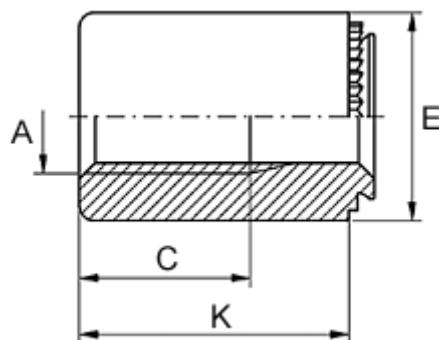

Article number: 12509800250500
Description: KLEE-coil 509 800 250.500
M5 Stainless 1.4305

Measures



| | |
|---------------------------------|--------------|
| Female thread A | = M5 |
| Height K | = 9 |
| Min distance to edge | = 4.0 |
| Outer diameter E | = 9 |
| Plate thickness | = 1.5 to 2.3 |
| Recommended bore diameter +0.05 | = 6.00 |
| Thread length | = 8.0 |